





# OUTLOOK

COLLECTION 1-1/8" COLLECTION  
28 MM

*drapery styling made easy*  
*draperies simplifiées*

**alendel<sup>®</sup>**  

---

*interior inspiration*

# contents

table de matières

## alendel<sup>®</sup>

*interior inspiration*

General Information Informations générales .....	5
Finials Embouts .....	6 - 11
End Cap Capuchon .....	12
Conventional Collection Collection Conventiennel .....	13 - 17
Ripple-fold/Pinch Pleat Tringles-Rail Ripple-Fold/Plis Pincer .....	18 - 23
How To Order Ripple-fold/Pinch Pleat Comment commander Tringles-Rail Ripple-Fold/Plis Pincer .....	24
Ripple-Fold Calculator Guide Guide Calculatrice Ripple-Fold .....	25
Bay Windows Baies vitrées .....	26
Suggested Retail Price List Liste de prix de détail suggérée .....	27

ALENDEL FABRICS LTD.

T. 905.669.1998 1.800.387.9968

fabrics@alendel.com

alendel.com

OUTLOOK 

# OUTLOOK

table top display / affichage d'échantillons de comptoir

sold separately / vendu séparément

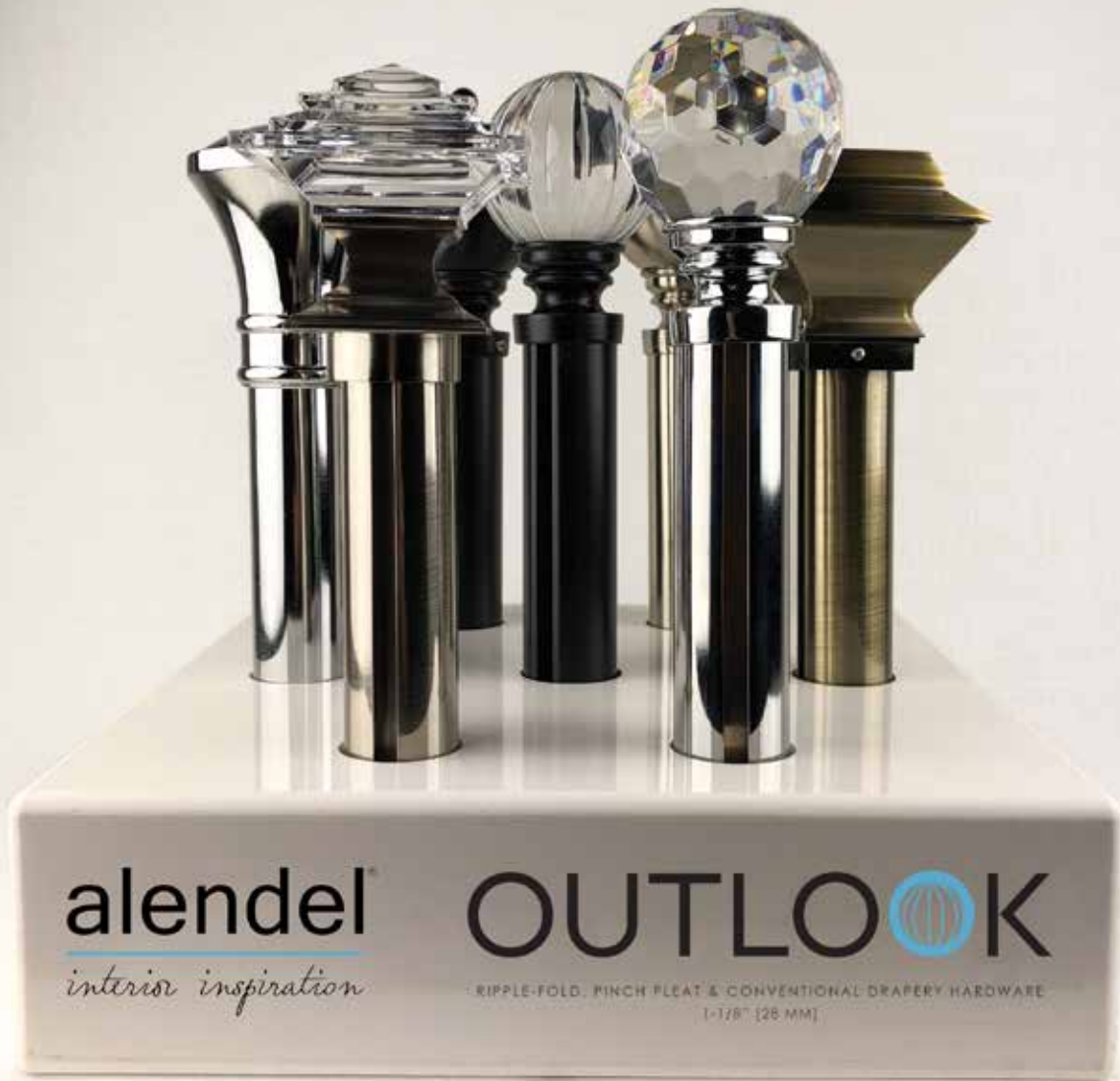

4 finishes / finitions



satin silver



chrome

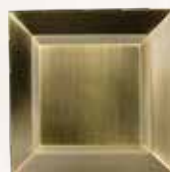

antique brass



black

Please contact your sales representative for more information.  
Contacter votre représentant des ventes pour d'informations.

# 28F3



28F3 - CH



28F3 - AB



28F3 - B

CODE	SOLD VENDU	DIAMETER DIAMÈTRE	LENGTH LONGEUR	WIDTH LARGEUR	MATERIAL MATÉRIAL	COLOURS COULEURS
28F3	PAIR PAIRE	1.125" 28 mm	3.25" 83 mm	2.25" 57 mm	METAL MÉTAL	AB - ANTIQUE BRASS B - BLACK CH - CHROME SS - SATIN SILVER

All images in this catalogue have been optimized to accurately represent colour and finish. Loaner/memo colour chips are available by request through your sales representative or Alendel Customer Service. Refer to [alendel.com](http://alendel.com) for additional product information.

Toutes les images dans ce catalogue ont été optimisées pour représenter avec précision la couleur et la finition. Des échantillons de couleur sont disponibles sur demande à partir de votre représentant de vente ou la service à la clientèle. Référez-vous à [alendel.com](http://alendel.com) pour des informations de produit supplémentaires.

# 28F2



28F2 - SS



28F2 - CH



28F2 - AB



28F2 - B

3.75" (96 mm)

CODE	SOLD VENDU	DIAMETER DIAMÈTRE	LENGTH LONGEUR	WIDTH LARGEUR	MATERIAL MATÉRIAL	COLOURS COULEURS
28F2	PAIR PAIRE	1.125" 28 mm	3.75" 96 mm	2.5" 64 mm	METAL MÉTAL	AB - ANTIQUE BRASS B - BLACK CH - CHROME SS - SATIN SILVER

All images in this catalogue have been optimized to accurately represent colour and finish. Loaner/memo colour chips are available by request through your sales representative or Alendel Customer Service. Refer to [alendel.com](http://alendel.com) for additional product information.

Toutes les images dans ce catalogue ont été optimisées pour représenter avec précision la couleur et la finition. Des échantillons de couleur sont disponibles sur demande à partir de votre représentant de vente ou la service à la clientèle. Référez-vous à [alendel.com](http://alendel.com) pour des informations de produit supplémentaires.

# 28F9



28F9 - CH



28F9 - AB



28F9 - B

CODE	SOLD VENDU	DIAMETER DIAMÈTRE	LENGTH LONGEUR	WIDTH LARGEUR	MATERIAL MATÉRIAL	COLOURS COULEURS
28F9	PAIR PAIRE	1.125" 28 mm	3.0" 76 mm	2.25" 57 mm	METAL MÉTAL	AB - ANTIQUE BRASS B - BLACK CH - CHROME SS - SATIN SILVER

All images in this catalogue have been optimized to accurately represent colour and finish. Loaner/memo colour chips are available by request through your sales representative or Alendel Customer Service. Refer to [alendel.com](http://alendel.com) for additional product information.

Toutes les images dans ce catalogue ont été optimisées pour représenter avec précision la couleur et la finition. Des échantillons de couleur sont disponibles sur demande à partir de votre représentant de vente ou la service à la clientèle. Référez-vous à [alendel.com](http://alendel.com) pour des informations de produit supplémentaires.



# 28F11



28F11 - SS



28F11 - CH

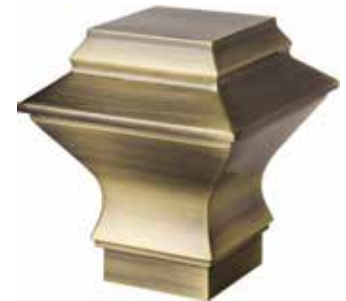

28F11 - AB



28F11 - B

CODE	SOLD VENDU	DIAMETER DIAMÈTRE	LENGTH LONGEUR	WIDTH LARGEUR	MATERIAL MATÉRIAL	COLOURS COULEURS
28F11	PAIR PAIRE	1.125" 28 mm	3.0" 76 mm	2.5" 64 mm	METAL MÉTAL	AB - ANTIQUE BRASS B - BLACK CH - CHROME SS - SATIN SILVER

All images in this catalogue have been optimized to accurately represent colour and finish. Loaner/memo colour chips are available by request through your sales representative or Alendel Customer Service. Refer to [alendel.com](http://alendel.com) for additional product information.

Toutes les images dans ce catalogue ont été optimisées pour représenter avec précision la couleur et la finition. Des échantillons de couleur sont disponibles sur demande à partir de votre représentant de vente ou la service à la clientèle. Référez-vous à [alendel.com](http://alendel.com) pour des informations de produit supplémentaires.

# 28F8



28F8 - SS



28F8 - CH



28F8 - AB



28F8 - B

3.75" (96 mm)

CODE	SOLD VENDU	DIAMETER DIAMÈTRE	LENGTH LONGEUR	WIDTH LARGEUR	MATERIAL MATÉRIAL	COLOURS COULEURS
28F8	PAIR PAIRE	1.125" 28 mm	3.75" 96 mm	2.75" 70 mm	METAL MÉTAL	AB - ANTIQUE BRASS B - BLACK CH - CHROME SS - SATIN SILVER

All images in this catalogue have been optimized to accurately represent colour and finish. Loaner/memo colour chips are available by request through your sales representative or Alendel Customer Service. Refer to [alendel.com](http://alendel.com) for additional product information.

Toutes les images dans ce catalogue ont été optimisées pour représenter avec précision la couleur et la finition. Des échantillons de couleur sont disponibles sur demande à partir de votre représentant de vente ou la service à la clientèle. Référez-vous à [alendel.com](http://alendel.com) pour des informations de produit supplémentaires.

# 28F16



28F16 - CH



28F16 - AB



28F16 - B



3.25" (83 mm)

3.25" (83 mm)

28F16 - SS

CODE	SOLD VENDU	DIAMETER DIAMÈTRE	LENGTH LONGEUR	WIDTH LARGEUR	MATERIAL MATÉRIAL	COLOURS COULEURS
28F16	PAIR PAIRE	1.125" 28 mm	3.25" 83 mm	3.25" 83 mm	METAL MÉTAL	AB - ANTIQUE BRASS B - BLACK CH - CHROME SS - SATIN SILVER

All images in this catalogue have been optimized to accurately represent colour and finish. Loaner/memo colour chips are available by request through your sales representative or Alendel Customer Service. Refer to [alendel.com](http://alendel.com) for additional product information.

Toutes les images dans ce catalogue ont été optimisées pour représenter avec précision la couleur et la finition. Des échantillons de couleur sont disponibles sur demande à partir de votre représentant de vente ou la service à la clientèle. Référez-vous à [alendel.com](http://alendel.com) pour des informations de produit supplémentaires.



28EC - SS



28EC - CH



28EC - AB



28EC - B

CODE	SOLD VENDU	DIAMETER DIAMÈTRE	LENGTH LONGEUR	WIDTH LARGEUR	MATERIAL MATÉRIAL	COLOURS COULEURS
28EC	PAIR PAIRE	1.125" 28 mm	1.25" 32 mm	0.5" 13 mm	METAL MÉTAL	AB - ANTIQUE BRASS B - BLACK CH - CHROME SS - SATIN SILVER

All images in this catalogue have been optimized to accurately represent colour and finish. Loaner/memo colour chips are available by request through your sales representative or Alendel Customer Service. Refer to [alendel.com](http://alendel.com) for additional product information.

Toutes les images dans ce catalogue ont été optimisées pour représenter avec précision la couleur et la finition. Des échantillons de couleur sont disponibles sur demande à partir de votre représentant de vente ou la service à la clientèle. Référez-vous à [alendel.com](http://alendel.com) pour des informations de produit supplémentaires.

POLES . JOINER . ELBOWS / TRINGLES . CONNECTEUR . ROTULES



CONVENTIONAL POLE  
TRINGLE CONVENTIONNEL

## 28P78

LENGTH / LONGEUR  
6.5" (78") - 1,981 mm

## 28P96

LENGTH / LONGEUR  
8' (96") - 2,438 mm

DIAMETER / DIAMÈTRE  
1.125" - 28 mm

MATERIAL / MATÉRIAL  
METAL / MÉTAL

SOLD / VENDU  
EACH / CHAQUE

AVAILABLE IN 2 STANDARD LENGTHS  
DISPONIBLES EN 2 LONGEURS STANDARD



SS - SATIN SILVER



CH - CHROME



AB - ANTIQUE BRASS



B - BLACK



JOINING SPLICE / CONNECTEUR

## 28PJ

DIAMETER / DIAMÈTRE  
1.125" - 28 mm

LENGTH / LONGEUR  
4.75" - 121 mm

MATERIAL / MATÉRIAL  
METAL / MÉTAL

COLOUR / COULEUR  
SILVER (only / seulement)

SOLD / VENDU  
EACH / CHAQUE



SINGLE CORNER ELBOW  
ROTULE SIMPLE

## 28JSC

DIAMETER / DIAMÈTRE  
1.125" - 28 mm

CORNER LENGTH / LONGEUR  
1.5" - 38 mm

MATERIAL / MATÉRIAL  
METAL / MÉTAL

SOLD / VENDU  
EACH / CHAQUE



SS - SATIN SILVER



CH - CHROME



AB - ANTIQUE BRASS



B - BLACK

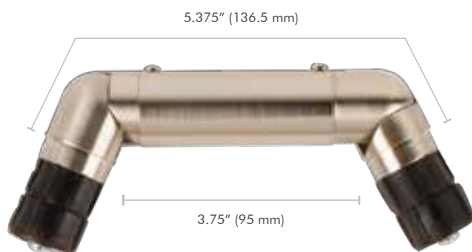

DOUBLE CORNER ELBOW  
ROTULE DOUBLE

## 28JDC

DIAMETER / DIAMÈTRE  
1.125" - 28 mm

LENGTH / LONGEUR  
5.375" - 136.5 mm

MATERIAL / MATÉRIAL  
METAL / MÉTAL

SOLD / VENDU  
EACH / CHAQUE



SS - SATIN SILVER



CH - CHROME



AB - ANTIQUE BRASS



B - BLACK



LINED ROUND RING  
ANNEAU ROND DOUBLÉ

## 28RND

INSIDE DIAMETER  
DIAMÈTRE D'INTÉRIEUR  
1.5" - 38 mm

MATERIAL / MATÉRIAL  
METAL / MÉTAL

SOLD / VENDU  
10 PKG / PKT 10



PASS OVER RING  
ANNEAU OUVERT

## 28RPO

INSIDE DIAMETER  
DIAMÈTRE D'INTÉRIEUR  
1.5" (38mm)

MATERIAL / MATÉRIAL  
METAL / MÉTAL

SOLD / VENDU  
10 PKG / PKT 10

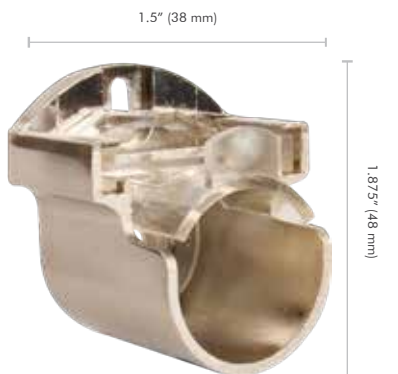

RECESS SUPPORT  
SOUTEIN NAISSANCE

## 28B8RS

DIAMETER / DIAMÈTRE  
1.125" - 28 mm

HEIGHT / HAUTEUR  
1.875" - 48 mm

WIDTH / LARGEUR  
1.5" - 38 mm

MATERIAL / MATÉRIAL  
METAL / MÉTAL

SOLD / VENDU  
EACH / CHAQUE



SS - SATIN SILVER



CH - CHROME



AB - ANTIQUE BRASS



B - BLACK



SS - SATIN SILVER



CH - CHROME



AB - ANTIQUE BRASS



B - BLACK



SS - SATIN SILVER



CH - CHROME



AB - ANTIQUE BRASS



B - BLACK

All images in this catalogue have been optimized to accurately represent colour and finish. Loaner/memo colour chips are available by request through your sales representative or Alendel Customer Service. Refer to [alendel.com](http://alendel.com) for additional product information.

Toutes les images dans ce catalogue ont été optimisées pour représenter avec précision la couleur et la finition. Des échantillons de couleur sont disponibles sur demande à partir de votre représentant de vente ou la service à la clientèle. Référez-vous à [alendel.com](http://alendel.com) pour des informations de produit supplémentaires.

IDC ADJUSTABLE BRACKET  
SUPPORT AJUSTABLE IDC

## 28B4IA

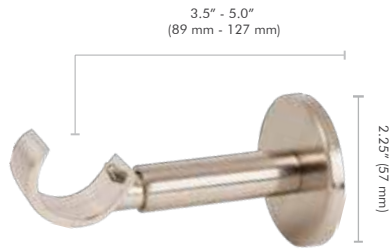

**DIAMETER / DIAMÈTRE**  
1.125" - 28 mm

**LENGTH / LONGUEUR**  
3.5" - 5" / 89 mm - 127 mm

**HEIGHT / HAUTER**  
2.25" - 57 mm

**MATERIAL / MATÉRIAL**  
METAL / MÉTAL

**SOLD / VENDU**  
EACH / CHAQUE



SS - SATIN SILVER



CH - CHROME



AB - ANTIQUE BRASS



B - BLACK

A-FRAME BRACKET  
SUPPORT DE CADRE-A

## 28B3AF



**DIAMETER / DIAMÈTRE**  
1.125" - 28 mm

**LENGTH / LONGUEUR**  
3.75" - 5.25"  
95 mm - 133 mm

**HEIGHT / HAUTER**  
2.625" - 67 mm

**MATERIAL / MATÉRIAL**  
METAL / MÉTAL

**SOLD / VENDU**  
EACH / CHAQUE



SS - SATIN SILVER



CH - CHROME



AB - ANTIQUE BRASS



B - BLACK

PASS OVER BRACKET  
SUPPORT OUVERT

## 28B1PO

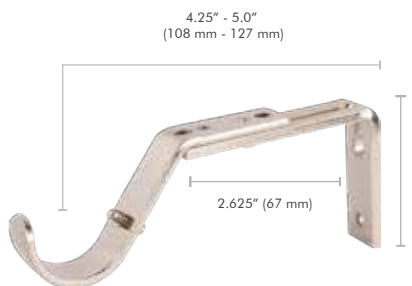

**DIAMETER / DIAMÈTRE**  
1.125" - 28 mm

**LENGTH / LONGUEUR**  
4.25" - 5.0"  
108 mm - 127 mm

**HEIGHT / HAUTER**  
2.0" - 51 mm

**MATERIAL / MATÉRIAL**  
METAL / MÉTAL

**SOLD / VENDU**  
EACH / CHAQUE



SS - SATIN SILVER



CH - CHROME



AB - ANTIQUE BRASS



B - BLACK

All images in this catalogue have been optimized to accurately represent colour and finish. Loaner/memo colour chips are available by request through your sales representative or Alendel Customer Service. Refer to [alendel.com](http://alendel.com) for additional product information.

Toutes les images dans ce catalogue ont été optimisées pour représenter avec précision la couleur et la finition. Des échantillons de couleur sont disponibles sur demande à partir de votre représentant de vente ou la service à la clientèle. Référez-vous à [alendel.com](http://alendel.com) pour des informations de produit supplémentaires.



STANDARD BRACKET  
SUPPORT STANDARD

## 28B2S

DIAMETER / DIAMÈTRE  
1.125" - 28 mm

LENGTH / LONGEUR  
3.75" - 5.5"  
95 mm - 140 mm

HEIGHT / HAUTER  
2" - 51 mm

MATERIAL / MATÉRIAL  
METAL / MÉTAL

SOLD / VENDU  
EACH / CHAQUE



SS - SATIN SILVER



CH - CHROME



AB - ANTIQUE BRASS



B - BLACK



WALL/CEILING BRACKET  
SUPPORT POUR MUR/PLAFOND

## 28B7TS

DIAMETER / DIAMÈTRE  
1.125" - 28 mm

LENGTH / LONGEUR  
2.375" - 60 mm

HEIGHT / HAUTER  
3.5" - 89 mm

MATERIAL / MATÉRIAL  
METAL / MÉTAL

SOLD / VENDU  
EACH / CHAQUE



SS - SATIN SILVER



CH - CHROME



AB - ANTIQUE BRASS



B - BLACK

All images in this catalogue have been optimized to accurately represent colour and finish. Loaner/memo colour chips are available by request through your sales representative or Alendel Customer Service. Refer to [alendel.com](http://alendel.com) for additional product information.

Toutes les images dans ce catalogue ont été optimisées pour représenter avec précision la couleur et la finition. Des échantillons de couleur sont disponibles sur demande à partir de votre représentant de vente ou la service à la clientèle. Référez-vous à [alendel.com](http://alendel.com) pour des informations de produit supplémentaires.





DOUBLE CEILING MOUNT BRACKET  
SUPPORT DOUBLE POUR PLAFOND

## 28B6DCM

DIAMETER / DIAMÈTRE  
1.125" - 28 mm

LENGTH / LONGUEUR  
2.625" - 67 mm

HEIGHT / HAUTER  
2.25" - 57 mm

MATERIAL / MATÉRIAL  
METAL / MÉTAL

SOLD / VENDU  
EACH / CHAQUE



SS - SATIN SILVER



CH - CHROME



AB - ANTIQUE BRASS



B - BLACK

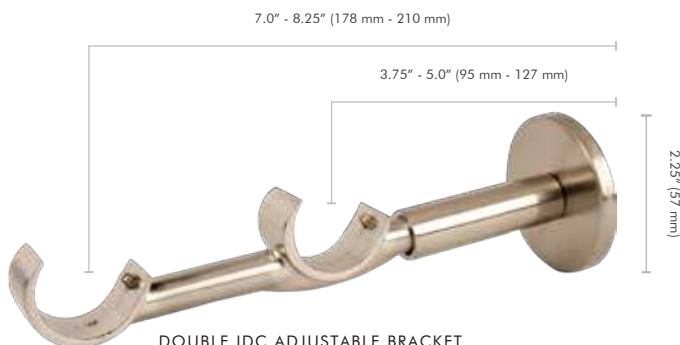

DOUBLE IDC ADJUSTABLE BRACKET  
SUPPORT AJUSTABLE DOUBLE IDC

## 28B5DIA

DIAMETER / DIAMÈTRE  
1.125" - 28 mm

LENGTH / LONGUEUR  
7.0" - 8.25" (178 mm - 210 mm)  
3.75" - 5.0" (95 mm - 127 mm)

HEIGHT / HAUTER  
2.25" (57 mm)

MATERIAL / MATÉRIAL  
METAL / MÉTAL

SOLD / VENDU  
EACH / CHAQUE



SS - SATIN SILVER



CH - CHROME



AB - ANTIQUE BRASS



B - BLACK

All images in this catalogue have been optimized to accurately represent colour and finish. Loaner/memo colour chips are available by request through your sales representative or Alendel Customer Service. Refer to [alendel.com](http://alendel.com) for additional product information.

Toutes les images dans ce catalogue ont été optimisées pour représenter avec précision la couleur et la finition. Des échantillons de couleur sont disponibles sur demande à partir de votre représentant de vente ou la service à la clientèle. Référez-vous à [alendel.com](http://alendel.com) pour des informations de produit supplémentaires.



RIPPLE-FOLD POLE  
TRINGLE-RAIL RIPPLE-FOLD

### 28CP72

LENGTH / LONGEUR  
6' (72")

### 28CP96

LENGTH / LONGEUR  
8' (96")

AVAILABLE IN 2 STANDARD LENGTHS.  
SILICONE SPRAY IS SUGGESTED FOR  
HEAVY WEIGHT FABRICS.  
DISPONIBLES EN 2 LONGEURS  
STANDARD.  
LE SPRAY DE SILICONE EST SUGGÉRÉ  
POUR LES  
TISSUS DE POIDS LOURDS.



SS - SATIN SILVER

CH - CHROME



AB - ANTIQUE BRASS

B - BLACK



RIPPLE-FOLD CONNECTOR RING  
ANNEAU CONNECTEUR RIPPLE-FOLD

### 28CPC

DIAMETER / DIAMÈTRE  
1.125" - 28 mm  
OPENING / OUVERTURE  
0.5" - 13 mm  
MATERIAL / MATÉRIAL  
METAL / MÉTAL  
SOLD / VENDU  
EACH / CHAQUE



SS - SATIN SILVER

CH - CHROME



AB - ANTIQUE BRASS

B - BLACK

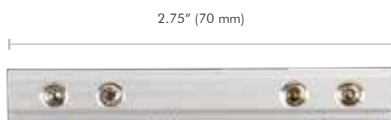

RIPPLE-FOLD CONNECTOR  
CONNECTEUR RIPPLE-FOLD

### 35CPJ

LENGTH / LONGEUR  
2.75" - 70 mm  
MATERIAL / MATÉRIAL  
METAL / MÉTAL  
COLOUR / COULEUR  
SILVER (only / seulement)  
SOLD / VENDU  
EACH / CHAQUE

END STOP  
BUTÉE D'EXTRÉMITÉ

### MES-1000



MATERIAL / MATÉRIAL  
METAL / MÉTAL  
COLOUR / COULEUR  
SILVER (only / seulement)  
SOLD / VENDU  
EACH / CHAQUE



END CAP WITH RING STOP  
CAPUCHON AVEC BUTTÉE

### 28EC

DIAMETER / DIAMÈTRE

1.125" - 28 mm

LENGTH / LONGEUR

0.5" - 13 mm

WIDTH / LARGEUR

1.25" - 32 mm

MATERIAL / MATÉRIAL

METAL / MÉTAL

SOLD / VENDU

PAIR / PAIRE



SS - SATIN SILVER



CH - CHROME



AB - ANTIQUE BRASS



B - BLACK

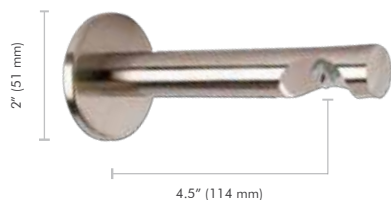

RIPPLE-FOLD BRACKET  
SUPPORT RIPPLE-FOLD

### 28CB45

DIAMETER / DIAMÈTRE

1.125" - 28 mm

LENGTH / LONGEUR

4.5" - 114 mm

HEIGHT / HAUTEUR

2" - 51 mm

MATERIAL / MATÉRIAL

METAL / MÉTAL

SOLD / VENDU

EACH / CHAQUE



SS - SATIN SILVER



CH - CHROME



AB - ANTIQUE BRASS



B - BLACK

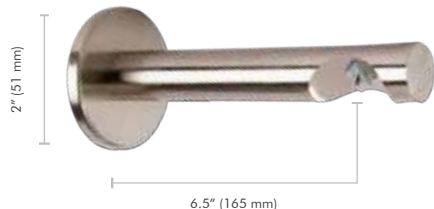

RIPPLE-FOLD BRACKET  
SUPPORT RIPPLE-FOLD

### 28CB65

DIAMETER / DIAMÈTRE

1.125" - 28 mm

LENGTH / LONGEUR

6.5" - 165 mm

HEIGHT / HAUTEUR

2" - 51 mm

MATERIAL / MATÉRIAL

METAL / MÉTAL

SOLD / VENDU

EACH / CHAQUE



SS - SATIN SILVER



CH - CHROME



AB - ANTIQUE BRASS



B - BLACK

RIPPLE-FOLD ADJUSTABLE BRACKET  
SUPPORT AJUSTABLE RIPPLE-FOLD

### 35CB11

LENGTH / LONGUEUR  
2.25" - 5.125"  
57 mm - 130 mm

HEIGHT / HAUTEUR  
2.375" - 60 mm

MATERIAL / MATÉRIAL  
METAL / MÉTAL

SOLD / VENDU  
EACH / CHAQUE



SS - SATIN SILVER

CH - CHROME



AB - ANTIQUE BRASS

B - BLACK

RIPPLE-FOLD ADJUSTABLE DOUBLE  
BRACKET  
SUPPORT AJUSTABLE DOUBLE  
RIPPLE-FOLD

### 35CB12

LENGTH / LONGUEUR  
2.25" - 3.5" / 5.125" - 6.5"  
57 mm - 89 mm / 130 mm - 165 mm

HEIGHT / HAUTEUR  
2.375" - 60 mm

MATERIAL / MATÉRIAL  
METAL / MÉTAL

SOLD / VENDU  
EACH / CHAQUE

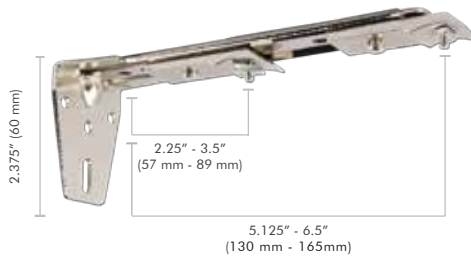

SS - SATIN SILVER

CH - CHROME



AB - ANTIQUE BRASS

B - BLACK

RIPPLE-FOLD CEILING MOUNT BRACKET  
SUPPORT DE PLAFOND RIPPLE-FOLD

### 35CB10

DIAMETER / DIAMÈTRE  
1.375" - 35 mm

LENGTH / LONGUEUR  
2" - 51 mm

WIDTH / LARGEUR  
0.875" - 22 mm

MATERIAL / MATÉRIAL  
METAL / MÉTAL

SOLD / VENDU  
EACH / CHAQUE

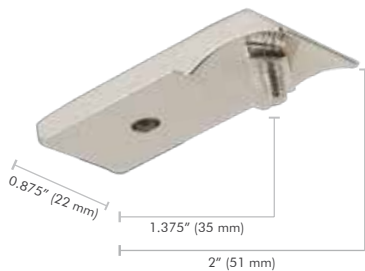

SS - SATIN SILVER

CH - CHROME

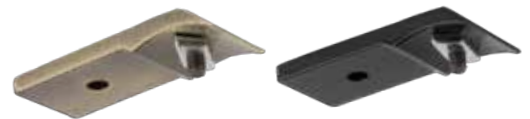

AB - ANTIQUE BRASS

B - BLACK

All images in this catalogue have been optimized to accurately represent colour and finish. Loaner/memo colour chips are available by request through your sales representative or Alendel Customer Service. Refer to alendel.com for additional product information.

Toutes les images dans ce catalogue ont été optimisées pour représenter avec précision la couleur et la finition. Des échantillons de couleur sont disponibles sur demande à partir de votre représentant de vente ou la service à la clientèle. Référez-vous à alendel.com pour des informations de produit supplémentaires.



**BM-80-804 | WHITE**  
LEFT BUTT MASTER - 3 SNAPS  
BUTT MASTER GAUCHE - 3 BOUTONS-PRESSION  
SOLD / VENDU  
EACH / CHAQUE



**BM-80-803 | WHITE**  
RIGHT BUTT MASTER - 3 SNAPS  
BUTT MASTER DROIT - 3 BOUTONS-PRESSION  
SOLD / VENDU  
EACH / CHAQUE



RIPPLE - FOLD



PLEAT / PLISSÉ



PLEAT / PLISSÉ



**MR-60-206 | WHITE**  
RIPPLE-FOLD OVERLAP MASTER CARRIER  
LEFT (6-WHEEL) - 3 SNAPS  
CHARIOT PRINCIPAL AVEC  
CHEVAUCHEMENT RIPPLE-FOLD GAUCHE  
(6 ROUES) 3 BOUTONS-PRESSION  
SOLD / VENDU  
EACH / CHAQUE



**MR-60-205 | WHITE**  
RIPPLE-FOLD OVERLAP MASTER CARRIER  
RIGHT (6-WHEEL) - 3 SNAPS  
CHARIOT PRINCIPAL AVEC  
CHEVAUCHEMENT RIPPLE-FOLD DROIT  
(6 ROUES) 3 BOUTONS-PRESSION  
SOLD / VENDU  
EACH / CHAQUE



**MR-60-206 | BLACK**  
RIPPLE-FOLD OVERLAP MASTER CARRIER  
LEFT (6-WHEEL) - 3 SNAPS  
CHARIOT PRINCIPAL AVEC  
CHEVAUCHEMENT RIPPLE-FOLD GAUCHE  
(6 ROUES) 3 BOUTONS-PRESSION  
SOLD / VENDU  
EACH / CHAQUE



**MR-60-205 | BLACK**  
RIPPLE-FOLD OVERLAP MASTER CARRIER  
RIGHT (6-WHEEL) - 3 SNAPS  
CHARIOT PRINCIPAL AVEC  
CHEVAUCHEMENT RIPPLE-FOLD DROIT  
(6 ROUES) 3 BOUTONS-PRESSION  
SOLD / VENDU  
EACH / CHAQUE



**MP-80-804 | WHITE**  
OVERLAP MASTER CARRIER FOR  
DRAW WAND - LEFT (8-WHEEL)  
CHARIOT PRINCIPAL AVEC  
CHEVAUCHEMENT POUR LANCE RIDEAUX  
GAUCHE (8 ROUES)  
SOLD / VENDU  
EACH / CHAQUE



**MP-80-803 | WHITE**  
OVERLAP MASTER CARRIER FOR  
DRAW WAND - RIGHT (8-WHEEL)  
CHARIOT PRINCIPAL AVEC  
CHEVAUCHEMENT POUR LANCE RIDEAUX  
DROIT (8 ROUES)  
SOLD / VENDU  
EACH / CHAQUE



**MP-80-804 | BLACK**  
OVERLAP MASTER CARRIER FOR  
DRAW WAND - LEFT (8-WHEEL)  
CHARIOT PRINCIPAL AVEC  
CHEVAUCHEMENT POUR LANCE RIDEAUX  
GAUCHE (8 ROUES)  
SOLD / VENDU  
EACH / CHAQUE



**MP-80-803 | BLACK**  
OVERLAP MASTER CARRIER FOR DRAW  
WAND - RIGHT (8-WHEEL)  
CHARIOT PRINCIPAL AVEC  
CHEVAUCHEMENT POUR LANCE RIDEAUX  
DROIT (8 ROUES)  
SOLD / VENDU  
EACH / CHAQUE

All images in this catalogue have been optimized to accurately represent colour and finish. Loaner/memo colour chips are available by request through your sales representative or Alendel Customer Service. Refer to [alendel.com](http://alendel.com) for additional product information.

Toutes les images dans ce catalogue ont été optimisées pour représenter avec précision la couleur et la finition. Des échantillons de couleur sont disponibles sur demande à partir de votre représentant de vente ou la service à la clientèle. Référez-vous à [alendel.com](http://alendel.com) pour des informations de produit supplémentaires.



WHITE

120% WHEELED RIPPLE-FOLD CARRIERS  
120% ROULÉ BOUTON RIPPLE-FOLD

### WR-20-1200

SPECIFY COLOUR WHEN ORDERING  
SPÉCIFIER LA COULEUR LORS DE LA  
COMMANDE

SPACING  
ESPACEMENT  
1.875" - 48 mm

SOLD / VENDU  
EACH / CHAQUE



BLACK

120% WHEELED RIPPLE-FOLD CARRIERS  
120% ROULÉ BOUTON RIPPLE-FOLD

### WR-20-1200

SPECIFY COLOUR WHEN ORDERING  
SPÉCIFIER LA COULEUR LORS DE LA  
COMMANDE

SPACING  
ESPACEMENT  
1.875" - 48 mm

SOLD / VENDU  
EACH / CHAQUE



WHITE

100% WHEELED RIPPLE-FOLD CARRIERS  
100% ROULÉ BOUTON RIPPLE-FOLD

### WR-20-1000

SPECIFY COLOUR WHEN ORDERING  
SPÉCIFIER LA COULEUR LORS DE LA  
COMMANDE

SPACING  
ESPACEMENT  
2.125" - 54 mm

SOLD / VENDU  
EACH / CHAQUE



BLACK

100% WHEELED RIPPLE-FOLD CARRIERS  
100% ROULÉ BOUTON RIPPLE-FOLD

### WR-20-1000

SPECIFY COLOUR WHEN ORDERING  
SPÉCIFIER LA COULEUR LORS DE LA  
COMMANDE

SPACING  
ESPACEMENT  
2.125" - 54 mm

SOLD / VENDU  
EACH / CHAQUE



WHITE

80% WHEELED RIPPLE-FOLD CARRIERS  
80% ROULÉ BOUTON RIPPLE-FOLD

### WR-20-8000

SPECIFY COLOUR WHEN ORDERING  
SPÉCIFIER LA COULEUR LORS DE LA  
COMMANDE

SPACING  
ESPACEMENT  
2.375" - 60 mm

SOLD / VENDU  
EACH / CHAQUE



BLACK

80% WHEELED RIPPLE-FOLD CARRIERS  
80% ROULÉ BOUTON RIPPLE-FOLD

### WR-20-8000

SPECIFY COLOUR WHEN ORDERING  
SPÉCIFIER LA COULEUR LORS DE LA  
COMMANDE

SPACING  
ESPACEMENT  
2.375" - 60 mm

SOLD / VENDU  
EACH / CHAQUE



WHITE

60% WHEELED RIPPLE-FOLD CARRIERS  
60% ROULÉ BOUTON RIPPLE-FOLD

### WR-20-6000

SPECIFY COLOUR WHEN ORDERING  
SPÉCIFIER LA COULEUR LORS DE LA  
COMMANDE

SPACING  
ESPACEMENT  
2.625" - 67 mm

SOLD / VENDU  
EACH / CHAQUE



BLACK

60% WHEELED RIPPLE-FOLD CARRIERS  
60% ROULÉ BOUTON RIPPLE-FOLD

### WR-20-6000

SPECIFY COLOUR WHEN ORDERING  
SPÉCIFIER LA COULEUR LORS DE LA  
COMMANDE

SPACING  
ESPACEMENT  
2.625" - 67 mm

SOLD / VENDU  
EACH / CHAQUE

All images in this catalogue have been optimized to accurately represent colour and finish. Loaner/memo colour chips are available by request through your sales representative or Alendel Customer Service. Refer to [alendel.com](http://alendel.com) for additional product information.

Toutes les images dans ce catalogue ont été optimisées pour représenter avec précision la couleur et la finition. Des échantillons de couleur sont disponibles sur demande à partir de votre représentant de vente ou la service à la clientèle. Référez-vous à [alendel.com](http://alendel.com) pour des informations de produit supplémentaires.

DRAW WAND, SNAP TAPE, GLIDES / LANCE RIDEAUX, RUBAN BOUTON PRESSION, CHARIOTS



CLEAR

DRAW WAND  
LANCE RIDEAUX

**DW30**

LENGTH / LONGEUR  
2.5' (30")

**DW48**

LENGTH / LONGEUR  
4' (48")

COLOUR / COULEUR  
CLEAR (only / seulement)

MATERIAL / MATÉRIAL  
ACRYLIC / ACRYLIQUE

SOLD / VENDU  
EACH / CHAQUE



WHITE



BLACK

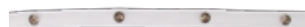

CLEAR

RIPPLE-FOLD SNAP TAPE  
RUBAN BOUTON PRESSION RIPPLE-FOLD

**RF-40-2845**

SPECIFY COLOUR WHEN ORDERING  
SPÉCIFIER LA COULEUR LORS DE LA  
COMMANDE

SNAP SPACING  
ESPACEMENT DES BOUTONS  
4.25" - 108 mm

SOLD / VENDU  
YARD / VERGE



WHITE



BLACK

PINCH PLEAT  
3/4" BALL BEARING GLIDES  
CHARIOTS 3/4" ROULEMENT À BILLES

**WC-20-9678**

SPECIFY COLOUR WHEN ORDERING  
SPÉCIFIER LA COULEUR LORS DE LA  
COMMANDE

SOLD / VENDU  
EACH / CHAQUE

All images in this catalogue have been optimized to accurately represent colour and finish. Loaner/memo colour chips are available by request through your sales representative or Alendel Customer Service. Refer to [alendel.com](http://alendel.com) for additional product information.

Toutes les images dans ce catalogue ont été optimisées pour représenter avec précision la couleur et la finition. Des échantillons de couleur sont disponibles sur demande à partir de votre représentant de vente ou la service à la clientèle. Référez-vous à [alendel.com](http://alendel.com) pour des informations de produit supplémentaires.

# HOW TO ORDER OUTLOOK RIPPLE-FOLD OR PINCH PLEAT

COMMENT COMMANDER OUTLOOK POUR TRINGLES À RIDEAUX RIPPLE-FOLD OU PLIS PINCER

Step By Step Guide / Guide étape par étapes

## 1 Select Finish

Sélectionner le fini



## 2 Select Finial Or End Cap

Sélectionner embouts et/ou capuchons d'extrémité



## 3 Select The Pole Size

Sélectionner la taille de votre tringle



## 4 Select The Connector & The Connector Ring (if required)

Sélectionner le connecteur et la anneau de connecteur (si requis)



## 5 Select The Brackets

Sélectionner les supports muraux



## 6 Select The Components

Sélectionner les composantes

### A Ripple-Fold Ripple-Fold

For butt master carrier / Pour rideaux Ondulés



For over / underlap carrier / Pour porte-cheval supérieur/inférieur



### B Wheeled Ripple-Fold Carrier (Choose Fullness) Transporteurs de rideau sur roues (choisir l'empleur)



### D End Stop Butée d'extrémité



### C Snap Tape Ruban à boutons pression



### E Pinch Pleat For over / underlap carrier Pour glisseur de croisement gauche/droite



### F Pinch Pleat Glides Chariots



### G End Stop Butée d'extrémité



## 7 Select The Draw Wand

Sélectionnez la lance rideaux





# OUTLOOK

## FOR OVER / UNDERLAP CARRIER

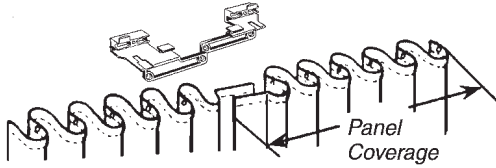

## FOR BUTT MASTER CARRIER

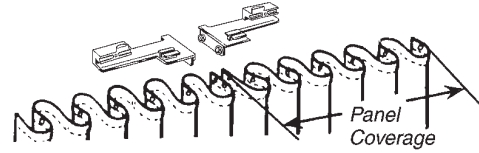

FABRIC WIDTH HEMMED	PANEL COVERAGE				STACK BACK WIDTH	# OF CARRIERS
	120% FULLNESS	100% FULLNESS	80% FULLNESS	60% FULLNESS		
35 1/2	10-14	11-16	13-17	14-19	8	8
44	14-18	18-20	17-22	19-24	9	10
52 1/2	18-21	20-24	22-27	24-30	9 1/2	12
61	21-25	24-28	27-32	30-35	10 1/2	14
69 1/2	25-29	28-32	32-36	35-40	11 1/2	16
78	29-33	32-37	36-41	40-45	12 1/2	18
86 1/2	33-36	37-41	41-46	45-51	13 1/2	20
95	36-40	41-45	46-51	51-56	14 1/2	22
103 1/2	40-44	45-50	51-55	56-61	15	24
112	44-48	50-54	55-60	61-66	16	26
120 1/2	48-51	54-58	60-65	66-72	16 1/2	28
129	51-55	58-62	65-70	72-77	17 1/2	30
137 1/2	55-59	62-66	70-74	77-82	18 1/2	32
146	59-63	66-71	74-79	82-87	19 1/2	34
154 1/2	63-66	71-75	79-84	87-93	20 1/2	36
163	66-70	75-79	84-89	93-98	21 1/2	38
171 1/2	70-74	79-84	89-93	98-103	22	40
180	74-78	84-88	93-98	103-108	22 1/2	42
188 1/2	78-81	88-92	98-103	108-114	23 1/2	44
197	81-85	92-96	103-108	114-119	24 1/2	46
205 1/2	85-89	96-101	108-112	119-124	25	48
214	89-93	101-105	112-117	124-129	25 1/2	50
222 1/2	93-96	105-109	117-122	129-135	26 1/2	52
231	96-100	109-113	122-127	135-140	27 1/2	54
239 1/2	100-104	113-118	127-131	140-145	28 1/2	56
248	104-108	118-122	131-136	145-150	29	58
256 1/2	108-111	122-126	136-141	150-156	30	60
265	111-115	126-130	141-146	156-161	31	62
273 1/2	115-119	130-136	146-150	161-166	31 1/2	64
282	119-123	136-139	150-155	166-171	32 1/2	66
290 1/2	123-126	139-143	155-160	171-176	33 1/2	68
299	126-130	143-147	160-165	176-182	34 1/2	70
307 1/2	130-134	147-152	165-169	182-187	35 1/2	72
316	134-138	152-156	169-174	187-192	36 1/2	74
324 1/2	138-141	156-160	174-179		37	76
333	141-145	160-164	179-184		38	78
341 1/2	145-149	164-168	184-188		39	80
350	149-153	168-173	188-193		39 1/2	82
358 1/2	153-156	173-177			40 1/2	84
367	156-160	177-181			41 1/2	86
375 1/2	160-164	181-186			42 1/2	88
384	164-168	186-190			43 1/2	90
392 1/2	168-171				44 1/2	92
401	171-175				45 1/2	94
409 1/2	175-179				46	96
418	179-183				47	98
426 1/2	183-186				48	100
435	186-190				49 1/2	102

FABRIC WIDTH HEMMED	PANEL COVERAGE				STACK BACK WIDTH	# OF CARRIERS
	120% FULLNESS	100% FULLNESS	80% FULLNESS	60% FULLNESS		
34	13-13	13-14	13-16	16-18	5 1/2	8
42 1/2	14-16	15-19	17-21	19-23	6 1/2	10
51	17-20	20-23	22-26	24-28	7 1/2	12
59 1/2	21-24	24-27	27-30	29-34	8	14
68	25-28	28-31	31-35	35-39	9	16
76 1/2	29-31	32-36	36-40	40-44	9 1/2	18
85	32-35	37-40	41-45	45-49	10 1/2	20
93 1/2	36-39	41-44	46-49	50-55	11 1/2	22
102	40-43	45-48	50-54	56-60	12 1/2	24
110 1/2	44-46	49-53	55-59	61-65	13 1/2	26
119	47-50	54-57	60-64	66-70	14	28
127 1/2	51-54	58-61	65-68	71-76	15	30
136	55-58	62-65	69-73	77-81	15 1/2	32
144 1/2	59-61	66-70	74-78	82-86	16 1/2	34
153	62-65	71-74	79-83	87-91	17 1/2	36
161 1/2	66-69	75-78	84-87	92-97	18 1/2	38
170	70-73	79-82	88-92	98-102	19 1/2	40
178 1/2	74-76	83-87	93-97	103-107	20	42
187	77-80	88-91	98-102	108-112	21	44
195 1/2	81-84	92-95	103-106	113-118	22	46
204	85-88	96-99	107-111	119-123	22 1/2	48
212 1/2	89-91	100-104	112-116	124-128	23 1/2	50
221	92-95	105-108	117-121	129-133	24 1/2	52
229 1/2	96-99	109-112	122-125	134-139	25 1/2	54
238	100-103	113-116	126-130	140-144	26 1/2	56
246 1/2	104-106	117-121	131-135	145-149	27 1/2	58
255	107-110	122-125	136-140	150-154	28 1/2	60
263 1/2	111-114	126-129	141-144	155-160	29 1/2	62
272	115-118	130-133	145-149	161-165	30	64
280 1/2	119-121	134-138	150-154	166-170	31	66
289	122-125	139-142	155-159	171-175	32	68
297 1/2	126-129	143-146	160-163	176-181	32 1/2	70
306	130-133	147-150	164-168	182-186	33 1/2	72
314 1/2	134-136	151-155	169-173	187-191	34 1/2	74
323	137-140	156-159	174-178	192-196	35 1/2	76
331 1/2	141-144	160-163	179-182		36 1/2	78
340	145-148	164-167	183-187		37 1/2	80
348 1/2	149-151	168-172	188-192		38 1/2	82
357	152-155	173-176	193-197		39	84
365 1/2	156-159	177-180			40	86
374	160-163	181-184			41	88
382 1/2	164-166	185-189			41 1/2	90
391	167-170	190-193			42 1/2	92
399 1/2	171-174				43 1/2	94
408	175-178				44 1/2	96
416 1/2	179-181				45 1/2	98
425	182-185				46 1/2	100
433 1/2	186-189				47 1/2	102
442	190-193				48 1/2	104

# OUTLOOK

bay window . baie vitrée

3 SIDED BAY WINDOW - BAIE VITRÉE À 3 CÔTÉS  
(2 double corner elbows - 2 rotules double)

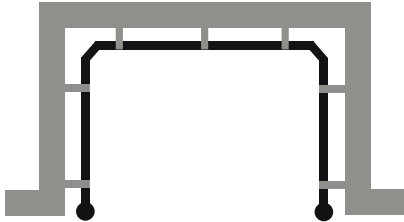

3 SIDED BAY WINDOW - BAIE VITRÉE À 3 CÔTÉS  
(2 double corner elbows - 2 rotules double)



5 SIDED BAY WINDOW - BAIE VITRÉE À 5 CÔTÉ  
(4 single corner elbows - 4 rotules simple)

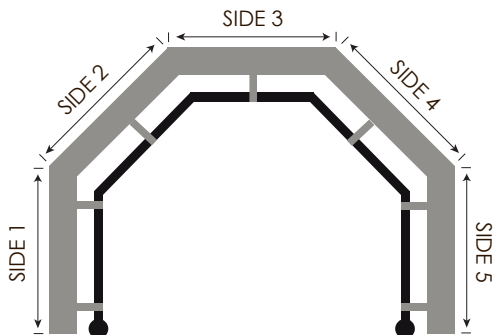

## FOR 3-SIDED BAY WINDOWS OR L-SHAPED WINDOWS

Double elbows are available for 3 sided bay windows. Double elbow joints bend to angles up to 90°.

\* Recommended for the average bay window spanning approx. 142" (360 cm) total length.

\* Listed components and their quantities are a recommendation only. We strongly recommend contacting a professional installer to determine exact requirements.

- 1 cut pole/tringle coupé - centre span/travée centrale
- 2 cut poles/tringles coupées - bay window return/retour baie vitrée
- 2 double elbows/rotules double
- 7 Pass over brackets/supports ouvert
- 38-42 Lined passing rings/anneaux ouvert
- 2 finials or endcaps with ring stop/embouts ou capuchon avec buttée

## POUR LES BAIES VITRÉE À 3-CÔTÉS OU FENÊTRES EN FORME DE-L

Double joints d'angle sont disponibles pour baie vitrée à 3-côté. Rotule double plient à des angles jusqu'à 90°.

\* Recommandé pour la baie vitrée moyenne couvrant environ 142" (360 cm) de longueur totale.

\* Composants cotée et leurs quantités sont qu'une recommandation. Nous vous recommandons fortement de contacter un installateur professionnel pour déterminer les besoins exacts.

## 5-SIDED BAY WINDOWS

Single elbows are available for 5 sided bay windows. Each single elbow joint has an interior angle of 45°.

Recommended for the average bay window spanning approx. 166" (420 cm) total length.

\* Listed components and their quantities are a recommendation only. We strongly recommend contacting a professional installer to determine exact requirements.

- 5 cut poles/tringles coupées
- 4 single elbows/rotules simple
- 7 Pass over brackets/supports ouvert
- 44 Lined pass over rings/anneaux ouvert
- 2 finials or endcaps with ring stop/capuchon avec buttée

## POUR LES BAIES VITRÉE À 5-CÔTÉS

Rotules simples sont disponibles pour baies vitrées 5-face.

Chaque articulation du rotule simple a un angle intérieur de 45°. Recommandé pour la baie vitrée moyenne couvrant environ 166" (420 cm) de longueur totale.

\* Composants cotée et leurs quantités sont qu'une recommandation. Nous vous recommandons fortement de contacter un installateur professionnel pour déterminer les besoins exacts.



**28JDC**  
Double Corner Elbow  
Rotule double

**28JSC**  
Single Elbow  
Rotule simple

**28B1PO**  
Pass Over Bracket  
Support ouvert

**28B4IA**  
IDC Adjustable Bracket  
Support ajustable IDC

**28RPO**  
Pass Over Rings  
Anneaux ouverts

(pass over bracket/support ouvert)

# OUTLOOK

SUGGESTED RETAIL PRICE / PRIX DE DÉTAIL SUGGÉRÉ

PRODUCT CODE CODE DE PRODUIT	PRICE PRIX	UOM UM
28F3		Pair/Paire
28F2		Pair/Paire
28F9		Pair/Paire
28F11		Pair/Paire
28F8		Pair/Paire
28F16		Pair/Paire
28EC		Pair/Paire

## CONVENTIONAL / CONVENTIONNEL

PRODUCT CODE CODE DE PRODUIT	PRICE PRIX	UOM UM
28P78		Each/Cheque
28P96		Each/Cheque
28PJ		Each/Cheque
28JSC		Each/Cheque
28JDC		Each/Cheque
28RND		10/Pkg / Packet/10
28PRO		10/Pkg / Packet/10
28B8RS		Each/Cheque
28B4IA		Each/Cheque
28B3AF		Each/Cheque
28B1PO		Each/Cheque
28B2S		Each/Cheque
28B7TS		Each/Cheque
28B6DCM		Each/Cheque
28B5DIA		Each/Cheque

**alendel**<sup>®</sup>  
*interior inspiration*

## RIPPLE-FOLD / RIPPLEFOLD

PRODUCT CODE CODE DE PRODUIT	PRICE PRIX	UOM UM
28CP72		Each/Cheque
28CP96		Each/Cheque
28CPC		Each/Cheque
35CPJ		Each/Cheque
MES-1000		Each/Cheque
28CB45		Each/Cheque
28CB65		Each/Cheque
35CB11		Each/Cheque
35CB12		Each/Cheque
35CB10		Each/Cheque
BM-80-804 WHITE		Each/Cheque
BM-80-803 WHITE		Each/Cheque
MR-60-206 WHITE		Each/Cheque
MR-60-205 WHITE		Each/Cheque
MR-60-206 BLACK		Each/Cheque
MR-60-205 BLACK		Each/Cheque
MP-80-804 WHITE		Each/Cheque
MP-80-803 WHITE		Each/Cheque
MP-80-804 BLACK		Each/Cheque
MP-80-803 BLACK		Each/Cheque
WR-20-1200 WHITE		Each/Cheque
WR-20-1200 BLACK		Each/Cheque
WR-20-1000 WHITE		Each/Cheque
WR-20-1000 BLACK		Each/Cheque
WR-20-8000 WHITE		Each/Cheque
WR-20-8000 BLACK		Each/Cheque
WR-20-6000 WHITE		Each/Cheque
WR-20-6000 BLACK		Each/Cheque
RF-40-2845 WHITE		Yard/Cour
RF-40-2845 BLACK		Yard/Cour
RF-40-2845 CLEAR		Yard/Cour
WC-20-9678 WHITE		Each/Cheque
WC-20-9678 BLACK		Each/Cheque
DW30		Each/Cheque
DW48		Each/Cheque



# alendel<sup>®</sup>

---

*interior inspiration*

ALENDEL FABRICS LTD.

T. 905.669.1998 - 1.800.387.9968 [fabrics@alendel.com](mailto:fabrics@alendel.com)

[alendel.com](http://alendel.com)